

**VALVOLE SNAP-IN PER AUTO**  
**SNAP-IN VALVES FOR CARS**  
**VALVES POUR VOITURES EN CAOUTCHOUC**



3040001IT



3040002IT



3040003IT



3040004IT



3040005











3040006IT



3040007

**Valvole tubeless in EPDM stelo in ottone**  
**EPDM tubeless valves brass stem**  
**Valves tubeless en EPDM tige en laiton**

Codice Code Code	Mod. Mod. Mod.	Lungh. mm Length mm Longueur mm	Base Base Base	Foro Hole Trou	Max Bar Max bar Bar max	Applicazione Application Application
3040001IT	TR412	33	19,5	11,3	4,5	 
3040002IT	TR413	43	19,5	11,3	4,5	
3040003IT	TR414	49	19,5	11,3	4,5	
3040004IT	TR414L	56,5	19,5	11,3	4,5	
3040005	TR 415	43	23,5	15,7	4,5	
3040006IT	TR418	61,5	19,5	11,3	4,5	
3040007	TR 423	74	19,5	11,3	4,5	
3040008	TR 425	60,5	23,5	15,7	4,5	

- STELO IN OTTONE
- BRASS STEM
- TIGE EN LAITON

**Valvole tubeless in EPDM smontate in 2 pezzi**  
**Rubber tubeless valves EPDM demounted in 2 pieces**  
**Valves tubeless en EPDM démontées en 2 pièces**

Codice Code Code	Mod. Mod. Mod.	Lungh. mm Length mm Longueur mm	Base Base Base	Foro Hole Trou	Max Bar Max bar Bar max	Applicazione Application Application
3040001ITD-2	TR412	33	19,5	11,3	4,5	
3040002ITD-2	TR413	43	19,5	11,3	4,5	
3040003ITD-2	TR414	49	19,5	11,3	4,5	



**Valvole tubeless in EPDM smontate in 3 pezzi**  
**Rubber tubeless valves EPDM demounted in 3 pieces**  
**Valves tubeless en EPDM démontées en 3 pièces**

Codice Code Code	Mod. Mod. Mod.	Lungh. mm Length mm Longueur mm	Base Base Base	Foro Hole Trou	Max Bar Max bar Bar max	Applicazione Application Application
3040001ITD	TR412	33	19,5	11,3	4,5	
3040002ITD	TR413	43	19,5	11,3	4,5	
3040003ITD	TR414	49	19,5	11,3	4,5	



**Valvole tubeless cromate - Tubeless chromed valves**  
**Valves tubeless chromé**

Codice Code Code	Mod. Mod. Mod.	Lungh. mm Length in mm Longueur en mm	Base Base Base	Foro Hole Forure	Max Bar	Applicazione Application Application
3040008A	TR 412	33	19,5	11,3	4,5	
3040009	TR 413	42,5	19,5	11,3	4,5	
3040010	TR 414	49	19,5	11,3	4,5	
3040011	TR 418	61,5	19,5	11,3	4,5	



**Valvole tubeless interamente cromate - tubeless valves completely chromed - Valves tubeless complètement chromées**

Codice Code Code	Mod. Mod. Mod.	Lungh. mm Length in mm Longueur en mm	Base Base Base	Foro Hole Forure	Max Bar	Applicazione Application Application
3040011D	TR 412	33	19,5	11,3	4,5	
3040011E	TR 413	42,5	19,5	11,3	4,5	
3040011F	TR 414	49	19,5	11,3	4,5	



**Fluido lubrificante per montaggio valvole**  
**Lubricant fluid to mount rubber valves**  
**Fluide lubrifiant pour montage valves**

Codice Code Code	Descrizione Description Description	Contenuto Contents Contenu
3040011M	Fluido lubrificante per montaggio valvole Lubricant fluid to mount rubber valves Fluide lubrifiant pour montage valves	100 ml
3040011M-5	Fluido lubrificante per montaggio valvole Lubricant fluid to mount rubber valves Fluide lubrifiant pour montage valves	5 Lt



CONTRAPESCHI IN ALLUMINIO  
 BALANCING WEIGHTS  
 VALVOLE PER PNEUMATICI  
 VALVES AND EXTENSION  
 COPERTURE  
 CAPS  
 MONTAGGIO E MANUTENZIONE RUOTE  
 TIRE MOUNTING AND DISMOUNTING  
 OILI, COMPRESSE  
 COMPRESSED AIR  
 PNEUMATICI  
 PNEUMATICS  
 SOLLEVAMENTO E ACCESSORI  
 LIFTING AND ACCESSORIES  
 OILI E MANUTENZIONE  
 TIRE CARE AND MAINTENANCE  
 ATTREZZI E ACCESSORI PER  
 OTHER EQUIPMENTS AND ACCESSORIES  
 TPMS  
 TPMS

**VALVOLE SNAP-IN PER AUTO**  
**SNAP-IN VALVES FOR CARS**  
**VALVES POUR VOITURES EN CAOUTCHOUC**



3040002IT-AL



3040003IT-AL

**Valvole tubeless EPDM stelo alluminio**  
**EPDM tubeless valves aluminum stem**  
**Valves tubeless en EPDM avec aluminium embout**

Codice Code Code	Modello Model Modèle	Lungh. mm Length mm Longueur mm	Base Base Base	Foro Hole Forure	Max Bar	Applicazione Application Application
3040002IT-AL	TR 413 Alu	43	19,5	11,3	4,5	
3040003IT-AL	TR 414 Alu	49	19,5	11,3	4,5	

- STELO IN ALLUMINIO
- ALLUMINIUM STEM
- TIGE EN ALUMINIUM



**VALVOLE METALLO PER AUTO**  
**METAL VALVES FOR CARS**  
**VALVES POUR VOITURES EN MÉTAL**



**Valvole tubeless alte prestazioni per vettura**  
**High performance tubeless valves for car**  
**Valves tubeless high performance pour voiture**

Codice Code Code	Descrizione Description Description	Rif. Ref. Réf.	Lungh. mm Length in mm Longueur en mm	Max Bar	Torque Nm	Foro Hole Forure	Applicazione Application Application
3040011N	Valvola tubeless nichelata Nickel-plated tubeless valve Valve tubeless nickelée	-	26	14	3:5	8,3	
3040011P	Valvola tubeless nichelata Nickel-plated tubeless valve Valve tubeless nickelée	-	39	14	3:5	8,3	
3040012	Valvola tubeless nichelata Nickel-plated tubeless valve Valve tubeless nickelée	V2-04-1	35	14	9:14	11,3	
3040013	Valvola in ottone Brass valve Valve cuivrée	V2-04-1	35	14	9:14	11,3	
3040013B	Valvola in ottone Brass valve Valve cuivrée	V2-04-1	35	14	9:14	11,3	
3040014	Valvola tubeless nichelata Nickel-plated tubeless valve Valve tubeless nickelée	V2-05-1	39	14	3:5	11,3	
3040014A	Valvola tubeless nichelata con dado lungo e guarnizione in nylon Nickel-plated tubeless valve with long nut and nylon seal Valve tubeless nickelée avec écrou long et joint en nylon	-	42	14	3:5	11,3	
3040014B	Valvola tubeless nichelata con dado lungo Nickel-plated tubeless valve with long nut Valve tubeless nickelée avec écrou long	-	42	14	3:5	11,3	
3040014C	Valvola tubeless nichelata con dado corto Nickel-plated tubeless valve with short nut Valve tubeless nickelée avec écrou court	-	42	14	3:5	11,3	



**VALVOLE PER VEICOLI COMMERCIALI**  
**VALVES FOR COMMERCIAL VEHICLES**  
**VALVES POUR VÉHICULES COMMERCIAUX**



3040017W



3040017A



3040017B



3040017HW



3040017LW



3040017MW

**Valvole tubeless ad alta pressione per veicoli commerciali**  
**High pressure tubeless valves for commercial vehicles/ Valves tubeless haute pression pour véhicules commerciaux**

Codice Code Code	Descrizione Description Description	Rif. Ref. Réf.	Lungh. mm Length in mm Longueur en mm	Max Bar	Torque Nm	Foro Hole Forure	Applicazione Application Application
3040017	Valvola tubeless Snap-in Snap-in tubeless valve Valve tubeless Snap-in	TR 600 HP	44	5,5	–	11,3	
3040017W	Valvola tubeless Snap-in Tubeless snap-in valve Valve tubeless snap-in	TR600HP Wonder	43,8	5,5	–	11,3	
3040017A	Valvola tubeless Snap-in lunga Long Snap-in tubeless valve Valve tubeless Snap-in longue	TR 602 HP	63	5,5	–	11,3	
3040017AW	Valvola tubeless Snap-in lunga Long tubeless Snap-in valve Valve tubeless snap-in longue	TR602HP Wonder	62,4	5,5	–	11,3	
3040017B	Valvola tubeless Snap-in alta pressione High pressure Snap-in tubeless valve Valve tubeless Snap-in haute pression	TR 600 XHP	43,5	6,9	–	11,3	
3040017C	Valvola tubeless Snap-in alta pressione lunga High pressure long Snap-in tubeless valve Valve tubeless Snap-in longue haute pression	TR 602 XHP	62,1	6,9	–	11,3	
3040017E	Valvola tubeless Snap-in Snap-in tubeless valve Valve tubeless Snap-in	TR 801 HP	48	5,5	–	15,7	
3040017HW	Valvola nichelata alta pressione High pressure Nickel-plated tubeless valve Valve tubeless Valve tubeless nickelée	1203 Wonder	41	14	–	11,3	
3040017LW	Valvola nichelata alta pressione High pressure Nickel-plated tubeless valve Valve tubeless Valve tubeless nickelée	1204 Wonder	47	14	–	11,3	
3040017MW	Valvola nichelata alta pressione High pressure Nickel-plated tubeless valve Valve tubeless Valve tubeless nickelée	1207 Wonder	55	14	–	11,3	

**VALVOLE PER VEICOLI COMMERCIALI**  
**VALVES FOR COMMERCIAL VEHICLES**  
**VALVES POUR VÉHICULES COMMERCIAUX**



3040017H/L/M



3040017P/Q/R

Codice Code Code	Descrizione Description Description	Rif. Ref. Réf.	Lungh. mm Length in mm Longueur en mm	Max Bar	Torque Nm	Foro Hole Forure	Applicazione Application Application
3040017G	Valvola tubeless Snap-in a smontaggio facile CVV Snap-in tubeless valve easy disassembling CVV Valve tubeless Snap-in démontage facile CVV	CVV31	31	7,0	–	11,3	
3040017H	Valvola tubeless Snap-in a smontaggio facile CVV Snap-in tubeless valve easy disassembling CVV Valve tubeless Snap-in démontage facile CVV	CVV40	40	7,0	–	11,3	
3040017L	Valvola tubeless Snap-in a smontaggio facile CVV Snap-in tubeless valve easy disassembling CVV Valve tubeless Snap-in démontage facile CVV	CVV47	47	7,0	–	11,3	
3040017M	Valvola tubeless Snap-in a smontaggio facile CVV Snap-in tubeless valve easy disassembling CVV Valve tubeless Snap-in démontage facile CVV	CVV60	60	7,0	–	11,3	
3040017N	Valvola tubeless metallo per alte temperature e pressioni ASC-HT Tubeless metal valve for high temperatures and pressures ASC-HT Valve tubeless métal pour hautes températures et pressions ASC-HT	–	31	14,0	4:6	11,3	
3040017P	Valvola tubeless metallo per alte temperature e pressioni ASC-HT Tubeless metal valve for high temperatures and pressures ASC-HT Valve tubeless métal pour hautes températures et pressions ASC-HT	–	40	14,0	4:6	11,3	
3040017Q	Valvola tubeless metallo per alte temperature e pressioni ASC-HT Tubeless metal valve for high temperatures and pressures ASC-HT Valve tubeless métal pour hautes températures et pressions ASC-HT	–	47	14,0	4:6	11,3	
3040017R	Valvola tubeless metallo per alte temperature e pressioni ASC-HT Tubeless metal valve for high temperatures and pressures ASC-HT Valve tubeless métal pour hautes températures et pressions ASC-HT	–	60	14,0	4:6	11,3	





**VALVOLE PER MOTO**  
**VALVES FOR MOTORCYCLE**  
**VALVES POUR MOTOCYCLETTE**

**Valvole per moto, scooter, cicli**  
**Valves for motorcycle, scooter, bicycle**  
**Valves pour motocyclette, scooter, vélo**

Codice Code Code	Descrizione Description Description	Rif. Ref. Réf.	Lungh. mm Length in mm Longueur en mm	Max Bar	Torque Nm	Foro Hole Forure	Applicazione Application Application
3040019	Valvola tubeless in gomma Rubber tubeless valve Valve tubeless en caoutchouc	TR438	40,5	4,5	–	8,8	
3040020	Valvola diritta in metallo per camera d'aria Straight metal valve for air tube Valve droite en métal pour chambre à air	–	35	–	7:10	9	
3040021	Valvola tubeless diritta Straight tubeless valve Valve tubeless droite	V1-10-01	35	4,5	7:10	8,3	
3040021A	Valvola tubeless diritta in alluminio Straight tubeless alu valve Valve tubeless droite en aluminium	V1-10-01	35	4,5	3:5	8,3	
3040021AW	Valvola tubeless diritta in alluminio Straight tubeless alu valve Valve tubeless droite en aluminium	TUMO Wonder	35	4,5	3:5	8,3	



3040019



3040020



3040021



3040021AW

**Valvole invisibili / Invisible valves / Valves invisibles**

Codice Code Code	Descrizione Description Description	Note Notes Notes	Applicazione Application Application
3040028A	Kit valvole invisibili foro 11,3 mm Kit of invisible valves hole 11,3 mm Jeu de valves invisibles forure 11,3 mm	Contiene 4 valvole invisibili It contains 4 invisible valves Il contient 4 valves invisibles	



3040028A

**Valvole per moto, scooter, cicli**  
**Valves for motorcycle, scooter, bicycle**  
**Valves pour motocyclette, scooter, vélo**

Codice Code Code	Descrizione Description Description	Rif. Ref. Réf.	Lungh. mm Length in mm Longueur en mm	Torque Nm	Foro Hole Forure	Applicazione Application Application
3040022	Valvola tubeless 80° in alluminio 80° aluminium valve Valve en aluminium à 80°	–	25	3:5	8,3	
3040022A	Valvola tubeless 80° in alluminio 80° tubeless aluminium valve Valve tubeless en aluminium à 80°	–	25	3:5	11,3	
3040022C	Valvola tubeless in ottone nichelato Nickel-plated brass tubeless valve Valve tubeless en laiton nickelé	TR 430A	37	3:5	8,3	
3040022D	Valvola tubeless in ottone nichelato Nickel-plated brass tubeless valve Valve tubeless en laiton nickelé	TR 435	37	7:10	11,3	
3040022E	Valvola tubeless 80° in alluminio nera 80° tubeless aluminium valve black Valve tubeless en aluminium à 80° noir	–	25	3:5	11,3	
3040022F	Valvola tubeless 80° in alluminio nera 80° tubeless aluminium valve black Valve tubeless en aluminium à 80° noir	–	25	3:5	8,3	
3040023	Valvola tubeless scooter a 90° 90° tubeless scooter valve Valve tubeless pour scooter à 90°	–	30	–	11,3	
3040023W	Valvola tubeless scooter a 90° Scooter tubeless 90° valve Valve tubeless scooter 90°	TUSCO Wonder	30	–	11,3	
3040023C	Valvola tubeless scooter a 90° 90° tubeless scooter valve Valve tubeless pour scooter à 90°	–	30	–	8,3	



3040022



3040022A



3040022C



3040022D



3040022E



3040023W

**Valvole avvitabili autocarro per camera d'aria**

**Truck valves to be screwed for tube tyres/ Valves camion à visser pour pneus avec chambres à air**

Codice Code Code	Descrizione Description Description	Rif. Ref. Réf.	Mis. A Size A Dimension A	Mis. B Size B Dimension B	$\alpha$ $\alpha$ $\alpha$	Applicazione Application Application
3040070	Valv. avvitabile autocarro ad 1 curva 1 curve truck valve to be screwed Valve camion à visser à 1 courbe	V3-02-3	33	44,5	95°	
3040071	Valv. avvitabile autocarro ad 1 curva 1 curve truck valve to be screwed Valve camion à visser à 1 courbe	V3-02-7	22,5	71,5	100°	
3040071A	Valv. avvitabile autocarro ad 1 curva 1 curve truck valve to be screwed Valve camion à visser à 1 courbe	V3-02-8	20,5	89,5	94°	
3040072	Valv. avvitabile autocarro ad 1 curva 1 curve truck valve to be screwed Valve camion à visser à 1 courbe	V3-02-9	20,5	99,5	94°	
3040073	Valv. avvitabile autocarro ad 1 curva 1 curve truck valve to be screwed Valve camion à visser à 1 courbe	V3-02-16	20,5	149,5	90°	
3040073A	Valv. avvitabile autocarro ad 1 curva 1 curve truck valve to be screwed Valve camion à visser à 1 courbe	V3-02-17	20,5	156,5	90°	
3040073B	Valv. avvitabile autocarro ad 1 curva 1 curve truck valve to be screwed Valve camion à visser à 1 courbe	V3-02-19	20,5	60	94°	
3040074	Valv. avvitabile autocarro ad 1 curva 1 curve truck valve to be screwed Valve camion à visser à 1 courbe	V3-02-21	23,5	172	90°	

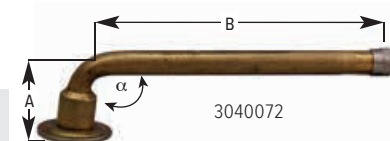

Codice Code Code	Descrizione Description Description	Rif. Ref. Réf.	Mis. A Size A Dim. A	Mis. B Size B Dim. B	Mis. C Size C Dim. C	$\alpha$ $\alpha$ $\alpha$	Applicazione Application Application
3040079	Valv. avvitabile autocarro a 2 curve 2 curves truck valve to be screwed Valve camion à visser à 2 courbes	V3-04-1	20,5	32	37	90°	
3040080	Valv. avvitabile autocarro a 2 curve 2 curves truck valve to be screwed Valve camion à visser à 2 courbes	V3-04-2	20,5	38	41,5	153°	
3040081	Valv. avvitabile autocarro a 2 curve 2 curves truck valve to be screwed Valve camion à visser à 2 courbes	V3-04-3	20	59	38,5	163°	
3040082	Valv. avvitabile autocarro a 2 curve 2 curves truck valve to be screwed Valve camion à visser à 2 courbes	V3-04-4	20	74	40	144°	
3040084	Valv. avvitabile autocarro a 2 curve 2 curves truck valve to be screwed Valve camion à visser à 2 courbes	V3-04-6	20	86	47,5	153°	

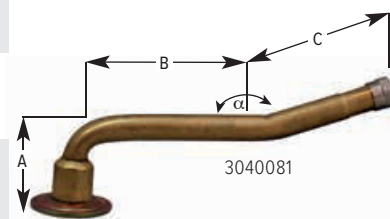

Codice Code Code	Descrizione Description Description	Rif. Ref. Réf.	Mis. A Size A Dimension A	Mis. B Size B Dimension B	$\alpha$ $\alpha$ $\alpha$	Applicazione Application Application
3040090	Valv. avvitabile autocarro a 3 curve 3 curves truck valve to be screwed Valve camion à visser à 3 courbes	V3-06-2	23,5	94	90°	
3040091	Valv. avvitabile autocarro a 3 curve 3 curves truck valve to be screwed Valve camion à visser à 3 courbes	V3-06-3	23,5	114	90°	
3040092	Valv. avvitabile autocarro a 3 curve 3 curves truck valve to be screwed Valve camion à visser à 3 courbes	V3-06-5	23,5	131	90°	
3040093	Valv. avvitabile autocarro a 3 curve 3 curves truck valve to be screwed Valve camion à visser à 3 courbes	V3-06-6	23	137	90°	
3040093B	Valv. avvitabile autocarro a 3 curve 3 curves truck valve to be screwed Valve camion à visser à 3 courbes	V3-06-8	24,5	112	90°	

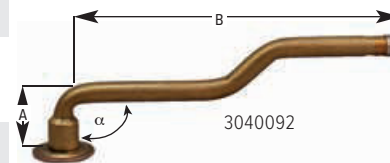

CONTROPESSO DI INALCANTORIA  
BALANCING WEIGHTS

VALVOLE PER PNEUMATICHE  
VALVES AND EXHAUSTS

CONFEZIONATI  
PACKAGING

MONTAGGIO E MANUTENZIONE DI  
THE MOUNTING AND MAINTENANCE

ORI. COMPRESSA  
COMPRESSED AIR

PROBLEME PNEUMATICI  
THE REPAIRING

SOLLEVAMENTO E ACCESSORI  
LIFTING AND ACCESSORIES

ORIGINE MANUTENZIONE  
TYPE CARE AND MAINTENANCE

ATTREZZATURE E ACCESSORI  
OTHER EQUIPMENTS AND ACCESSORIES

TPMS  
TPMS

# VALVOLE PER AUTOCARRO

## TRUCK VALVES

## VALVES POUR CAMION

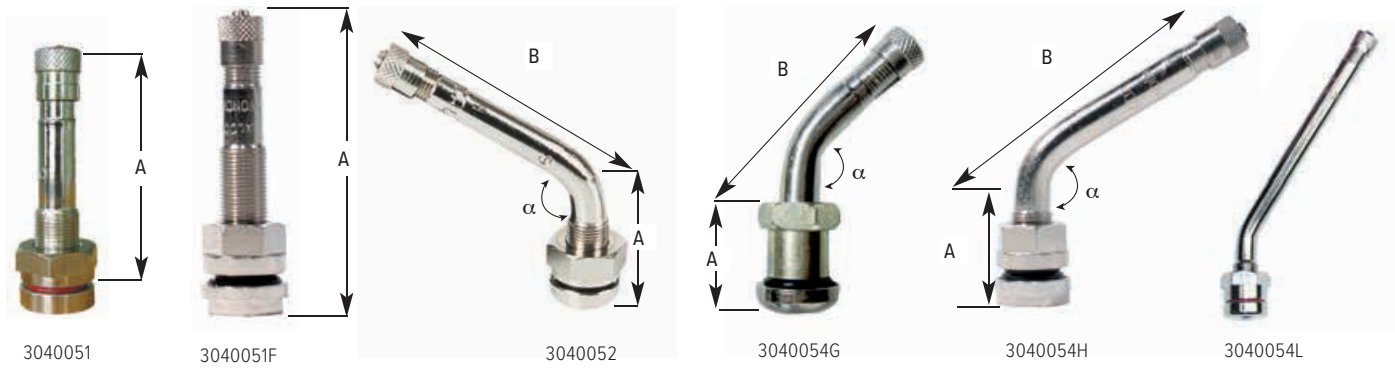

### Valvole tubeless autocarro nichelate per cerchi in lega

### Tubeless nickel-plated valves for truck alloy rims - Valves tubeless nickelées pour jantes camion en alliage

Codice Code Code	Descrizione Description Description	Rif. Ref. Réf.	Mis. A mm Size A mm Dimension A mm	Mis. B mm Size B mm Dimension B mm	$\alpha$ $\alpha$ $\alpha$	Applicazione Application Application
3040051	Valv. tubeless autocarro nichelata Truck tubeless nickel-plated valve Valve tubeless nickelée camion	TR 542	32	–	–	
3040051B	Valv. tubeless autocarro nichelata Truck tubeless nickel-plated valve Valve tubeless nickelée camion	TR 543	59	–	–	
3040051C	Valv. tubeless autocarro nichelata Truck tubeless nickel-plated valve Valve tubeless nickelée camion	TR 544	73	–	–	 Alcoa
3040051D	Valv. tubeless autocarro nichelata Truck tubeless nickel-plated valve Valve tubeless nickelée camion	TR 545	89	–	–	
3040051E	Valv. tubeless autocarro nichelata Truck tubeless nickel-plated valve Valve tubeless nickelée camion	TR 546	108	–	–	
3040051F	Valv. tubeless autocarro nichelata Truck tubeless nickel-plated valve Valve tubeless nickelée camion	–	53,5	–	–	
3040052	Valv. tubeless autocarro nichelata Truck tubeless nickel-plated valve Valve tubeless nickelée camion	TR 543C	23,5	35	45°	
3040053	Valv. tubeless autocarro nichelata Truck tubeless nickel-plated valve Valve tubeless nickelée camion	TR 543D	25	35	60°	
3040053A	Valv. tubeless autocarro nichelata Truck tubeless nickel-plated valve Valve tubeless nickelée camion	TR 543E	25	35	75°	
3040054	Valv. tubeless autocarro nichelata Truck tubeless nickel-plated valve Valve tubeless nickelée camion	TR 544D	25	49	60°	
3040054D	Valv. tubeless autocarro nichelata Truck tubeless nickel-plated valve Valve tubeless nickelée camion	TR 545D	25	66	60°	
3040054E	Valv. tubeless autocarro nichelata Truck tubeless nickel-plated valve Valve tubeless nickelée camion	TR 546D	25	85	60°	
3040054F	Valv. tubeless autocarro nichelata Truck tubeless nickel-plated valve Valve tubeless nickelée camion	TR 546E	25	85	75°	
3040054G	Valv. tubeless autocarro nichelata Truck tubeless nickel-plated valve Valve tubeless nickelée camion	V3-22-1	25	28	45°	
3040054H	Valv. tubeless autocarro nichelata Truck tubeless nickel-plated valve Valve tubeless nickelée camion	TR 554D	30	54	60°	
3040054L	Valv. tubeless autocarro nichelata Truck tubeless nickel-plated valve Valve tubeless nickelée camion	TR 546-36	25	85	36°	

# VALVOLE PER AUTOCARRO

## TRUCK VALVES

### VALVES POUR CAMION



Codice Code Code	Descrizione Description Description	Rif. Ref. Réf.	Mis. A mm Size A mm Dimension A mm	Mis. B mm Size B mm Dimension B mm	$\alpha$ $\alpha$ $\alpha$	Applicazione Application Application
3040054M	Valv. tubeless autocarro nichelata Truck tubeless nickel-plated valve Valve tubeless nickelée camion	1411/C	31	-	-	
3040054N	Valv. tubeless autocarro nichelata Truck tubeless nickel-plated valve Valve tubeless nickelée camion	1414/C Wonder	25	30	27°	
3040054P	Valv. tubeless autocarro nichelata Truck tubeless nickel-plated valve Valve tubeless nickelée camion	40MS	40	-	-	
3040054Q	Valv. tubeless autocarro nichelata Truck tubeless nickel-plated valve Valve tubeless nickelée camion	54MS	53,5	-	-	
3040054Q1	Valv. tubeless autocarro nichelata Truck tubeless nickel-plated valve Valve tubeless nickelée camion	60MS (Wonder 1333)	60	-	-	
3040054R	Valv. tubeless autocarro nichelata Truck tubeless nickel-plated valve Valve tubeless nickelée camion	70MS	40,5	28,5	7°	
3040054S	Valv. tubeless autocarro nichelata Truck tubeless nickel-plated valve Valve tubeless nickelée camion	70MS-27	35,5	28,5	27°	
3040054T	Valv. tubeless autocarro nichelata Truck tubeless nickel-plated valve Valve tubeless nickelée camion	70MS-45	35,5	28,5	45°	
3040054U	Valv. tubeless autocarro nichelata Truck tubeless nickel-plated valve Valve tubeless nickelée camion	70MS-60	35,5	28,5	60°	
3040054V	Valv. tubeless autocarro nichelata Truck tubeless nickel-plated valve Valve tubeless nickelée camion	TR 552	32,0	-	-	
3040054W	Valv. tubeless autocarro nichelata Truck tubeless nickel-plated valve Valve tubeless nickelée camion	TR 553	58,5	-	-	
3040054X	Valv. tubeless autocarro nichelata Truck tubeless nickel-plated valve Valve tubeless nickelée camion	TR 554	72,5	-	-	
3040054Y	Valv. tubeless autocarro nichelata Truck tubeless nickel-plated valve Valve tubeless nickelée camion	TR 554D	25	49	60°	
3040054Z	Valv. tubeless autocarro nichelata Truck tubeless nickel-plated valve Valve tubeless nickelée camion	TR 555D	25	66	60°	
3040055	Valv. tubeless autocarro nichelata Truck tubeless nickel-plated valve Valve tubeless nickelée camion	TR 555E	25	66	75°	



CONTRAPESOS DE BALANÇAMENTO  
BALANCING WEIGHTS  
 VALVULES PRODUZIDAS  
VALVES AND ACCESSORIES  
 COBERTORES E ENCAIXES DE  
COBERTURA  
COVERINGS  
 MONTES E ENCAIXES DE BARRAS  
THE MOUNTING AND DISMOUNTING  
 BARRAS DE COMPRESSÃO  
COMPRESSED AIR  
 PRODUZIDAS E MONTADAS  
THE REPAIRING  
 EQUIPAMENTOS E ACESSÓRIOS  
LIFTING AND ACCESSORIES  
 CILINDROS E MANUTENÇÃO  
THE CARE AND MAINTENANCE  
 EQUIPAMENTOS E ACESSÓRIOS  
OTHER EQUIPMENTS AND ACCESSORIES  
 UTENSÍLIOS E ACESSÓRIOS  
OTHER EQUIPMENTS AND ACCESSORIES  
 FERRAMENTAS E ACESSÓRIOS  
OTHER EQUIPMENTS AND ACCESSORIES  
 FERRAMENTAS E ACESSÓRIOS  
OTHER EQUIPMENTS AND ACCESSORIES

## VALVOLE PER AUTOCARRO

### TRUCK VALVES

### VALVES POUR CAMION







#### Valvole tubeless autocarro in ottone dritte Straight brass tubeless valves for truck Valves tubeless droites en laiton pour camion

Codice Code Code	Descrizione Description Description	Rif. Ref. Réf.	Lungh. mm Length in mm Longueur en mm	Foro Hole Forure	Applicazione Application Application
3040040	Valvola tubeless autocarro Truck tubeless valve Valve tubeless camion	V3-20-1	36	9,7	
3040040B	Valvola tubeless autocarro lunga Long truck tubeless valve Valve tubeless camion longue	V3-20-3	82	9,7	



3040040

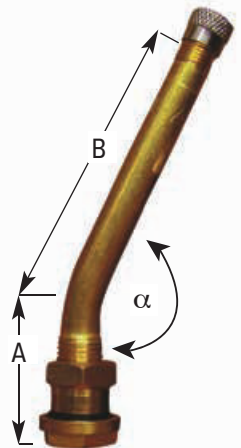

#### Valvole tubeless autocarro in ottone con una curva Brass tubeless truck valves with one curve Valves tubeless camion en laiton avec une courbe

Codice Code Code	Descrizione Description Description	Rif. Ref. Réf.	Mis. A mm Size A mm Dimension A mm	Mis. B mm Size B mm Dimension B mm	$\alpha$ $\alpha$ $\alpha$	Applicazione Application Application
3040041	Valvola tubeless autocarro Truck tubeless valve Valve tubeless camion	V3-20-5	25	40	27°	
3040042	Valvola tubeless autocarro Truck tubeless valve Valve tubeless camion	V3-20-7	25	50	27°	
3040043	Valvola tubeless autocarro Truck tubeless valve Valve tubeless camion	V3-20-4	25	60	27°	
3040044	Valvola tubeless autocarro Truck tubeless valve Valve tubeless camion	V3-20-6	25	85	27°	
3040046	Valvola tubeless autocarro Truck tubeless valve Valve tubeless camion	V0-07-3	30	95	27°	
3040047	Valvola tubeless autocarro Truck tubeless valve Valve tubeless camion	V3-20-10	50	25	27°	



3040043

#### Valvole tubeless autocarro in ottone con due curve Brass tubeless truck valves with two curves Valves tubeless camion en laiton avec deux courbes

Codice Code Code	Descrizione Description Description	Rif. Ref. Réf.	Mis. A mm Size A mm Dim. A mm	Mis. B mm Size B mm Dim. B mm	Mis. C mm Size C mm Dim. C mm	$\alpha$ $\alpha$ $\alpha$	Applicazione Application Application
3040047A	Valvola tubeless autocarro Truck tubeless valve Valve tubeless camion	TURNING 11 Wonder	41	22	65	27°	
3040049	Valvola tubeless autocarro Truck tubeless valve Valve tubeless camion	V3-20-11	25	45	25	27°	
3040049B	Valvola tubeless autocarro Truck tubeless valve Valve tubeless camion	V3-20-12	25	70	-	27°	

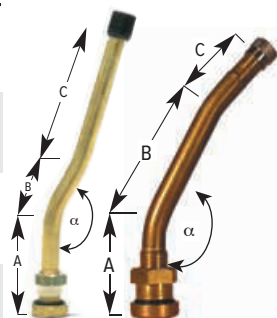

3040047A 3040049

**VALVOLE PER AUTOCARRO**  
**TRUCK VALVES**  
**VALVES POUR CAMION**



**Valvole tubeless autocarro - Tubeless valves for truck - Valves tubeless pour camion**

Codice Code Code	Descrizione Description Description	Rif. Ref. Réf.	Mis. A mm Size A mm Dimension A mm	Mis. B mm Size B mm Dimension B mm	$\alpha$ $\alpha$ $\alpha$	Applicazione Application Application
3040055A	Valvola tubeless autocarro Truck tubeless valve Valve tubeless camion	V3-21-1 TR 575	29	—	—	
3040055C	Valvola tubeless autocarro Truck tubeless valve Valve tubeless camion	V3-21-2	38	—	—	
3040055E	Valvola tubeless autocarro Truck tubeless valve Valve tubeless camion	V3-21-3	51	—	—	
3040055F	Valvola tubeless autocarro Truck tubeless valve Valve tubeless camion	TR 500A	51	26	23°	
3040055G	Valvola tubeless autocarro Truck tubeless valve Valve tubeless camion	V3-21-4	79	—	—	
3040055L	Valvola tubeless autocarro Truck tubeless valve Valve tubeless camion	V3-21-5	86	—	—	
3040055N	Valvola tubeless autocarro Truck tubeless valve Valve tubeless camion	V3-21-6	95	—	—	
3040055P	Valvola tubeless autocarro Truck tubeless valve Valve tubeless camion	V3-21-7	111	—	—	
3040055Q	Valvola tubeless autocarro Truck tubeless valve Valve tubeless camion	V3-21-8	127	—	—	
3040055R	Valvola tubeless autocarro Truck tubeless valve Valve tubeless camion	V3-21-9	33	51	90°	
3040055S	Valvola tubeless autocarro Truck tubeless valve Valve tubeless camion	V3-21-10	33	58	90°	
3040055T	Valvola tubeless autocarro Truck tubeless valve Valve tubeless camion	V3-21-11	33	67	90°	
3040055V	Valvola tubeless autocarro Truck tubeless valve Valve tubeless camion	V3-21-12	33	83	90°	
3040055W	Valvola tubeless autocarro Truck tubeless valve Valve tubeless camion	V3-22-1	25	28	45°	
3040055X	Valvola tubeless autocarro Truck tubeless valve Valve tubeless camion	—	35	—	110°	

CONTRAPESCHI PER MANICATA  
 BALANCING WEIGHTS  
 VALVOLE PER PNEUMATICHE  
 VALVES AND ACCESSORIES  
 COPERTURE PER PNEUMATICHE  
 COVERS  
 PNEUMATICHE E ACCESSORI PER  
 THE MOUNTING AND DISMOUNTING  
 PNEUMATIC AIR  
 PNEUMATICHE E ACCESSORI PER  
 THE REPAIRING  
 PNEUMATICHE E ACCESSORI PER  
 THE CARE AND MAINTENANCE  
 PNEUMATICHE E ACCESSORI PER  
 OTHER EQUIPMENTS AND ACCESSORIES  
 ATTREZZATURE E ACCESSORI PER  
 OTHER EQUIPMENTS AND ACCESSORIES  
 TRUCKS  
 TRUCKS

# VALVOLE PER AUTOCARRO

## TRUCK VALVES

## VALVES POUR CAMION

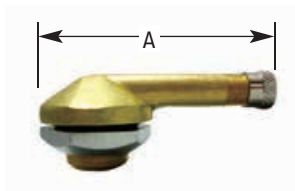

3040056

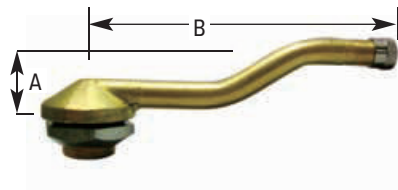

3040058

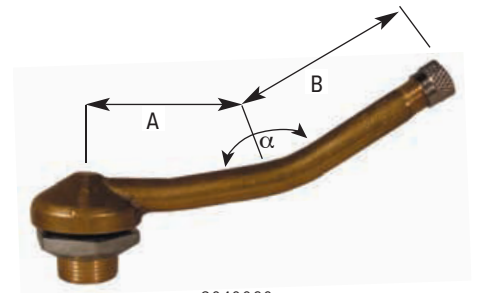

3040060

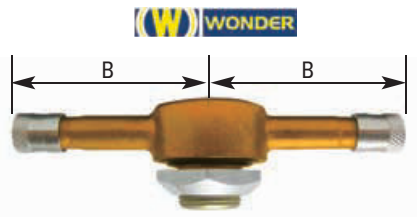

3040064

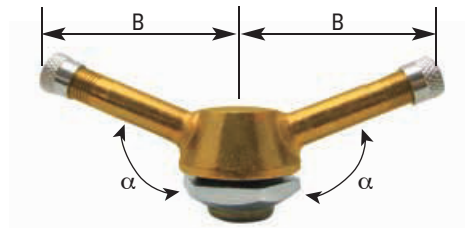

3040065



3040066B

### Valvole tubeless autocarro Tubeless valves for truck Valves tubeless pour camion

Codice Code Code	Descrizione Description Description	Rif. Ref. Réf.	Mis. A mm Size A mm Dimension A mm	Mis. B mm Size B mm Dimension B mm	$\alpha$ $\alpha$ $\alpha$	Applicazione Application Application
3040056	Valvola tubeless autocarro Truck tubeless valve Valve tubeless camion	V3-12-1	40	–	–	
3040056A	Valvola tubeless autocarro Truck tubeless valve Valve tubeless camion	V3-12-2	95	–	–	
3040057	Valvola tubeless autocarro Truck tubeless valve Valve tubeless camion	V3-13-1	27	42,5	153°	
3040058	Valvola tubeless autocarro Truck tubeless valve Valve tubeless camion	V3-14-1	14	72	–	
3040059	Valvola tubeless autocarro Truck tubeless valve Valve tubeless camion	V3-14-2	14	91	–	
3040059A	Valvola tubeless autocarro Truck tubeless valve Valve tubeless camion	V3-14-3	121	83	–	
3040060	Valvola tubeless autocarro Truck tubeless valve Valve tubeless camion	V3-13-2	10,5	79	126°	
3040061	Valvola tubeless autocarro Truck tubeless valve Valve tubeless camion	V3-16-1	36	29	150°	
3040064	Valvola tubeless autocarro Truck tubeless valve Valve tubeless camion	TUCA40 Wonder	–	45	–	
3040065	Valvola tubeless autocarro Truck tubeless valve Valve tubeless camion	TUCA41 Wonder	–	30	45°	
3040066B	Valvola tubeless autocarro Truck tubeless valve Valve tubeless camion	V3-15-2	26,5	44,5	95°	

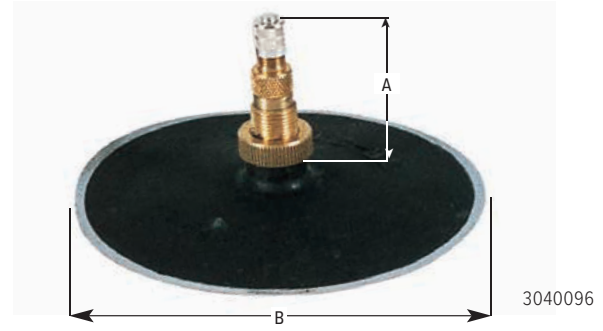
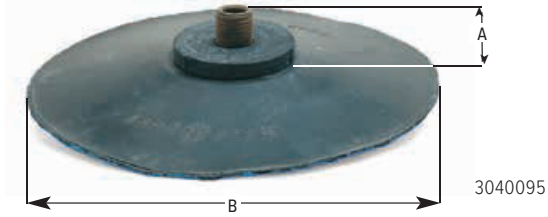

**Basi autovulcanizzanti**  
**Self curing bases**  
**Bases autovulcanisantes à froid**

Codice Code Code	Descrizione Description Description	Rif. Ref. Réf.	Mis. A Size A Dimen. A	Mis. B Size B Dimen. B	Applicazione Application Application
3040095	Base per valvola av. autovulcanizzante a freddo <i>Cold self-curing base for valve to be screwed</i> <i>Base autovulcanisante à froid pour valve à visser</i>	V3-08-3	10	110	
3040096	Valvola con base autovulcanizzante a freddo <i>Valve with cold self-curing base</i> <i>Valve avec base autovulcanisante à froid</i>	TR218A	50	110	
3040096N	Dado in nylon di ricambio per 3040096 <i>Spare nylon nut for 3040096</i> <i>Écrou en nylon de rechange pour 3040096</i>	—	—	—	
3040096B	Dado in ottone di ricambio per 3040096 <i>Spare brass nut for 3040096</i> <i>Écrou en laiton de rechange pour 3040096</i>	—	—	—	



**Valvole tubeless autocarro in ottone con una curva**  
**Brass tubeless truck valves with one curve**  
**Valves tubeless camion en laiton avec une courbe**

Codice Code Code	Descrizione Description Description	Rif. Ref. Réf.	Mis. A mm Size A mm Dimension A mm	Mis. B mm Size B mm Dimension B mm	$\alpha$ $\alpha$ $\alpha$	Applicazione Application Application
3040102	Valvola tubeless trattore <i>Tractor tubeless valve</i> <i>Valve tubeless tracteur</i>	TR621A	39	54,5	115°	
3040103	Valvola tubeless trattore <i>Tractor tubeless valve</i> <i>Valve tubeless tracteur</i>	TR622A	44,5	94,5	90°	
3040104	Valvola tubeless trattore <i>Tractor tubeless valve</i> <i>Valve tubeless tracteur</i>	TR623A	39	36,5	115°	





# VALVOLE PER AUTOCARRO

## TRUCK VALVES

## VALVES POUR CAMION



3040093L



3040093T



3040093U



3040093V



3040093W

### Valvole tubeless autocarro per TPMS TPMS tubeless truck tyre valves Valves tubeless pour camion pour TPMS

Codice Code	Descrizione Description	X-Ref X-Ref	Mis A mm Size A	Mis B mm Size B	Angolo Angle	Foro mm Hole	Applicazione Application
3040093L	Valvole tubeless autocarro per TPMS (vite inclusa) TPMS tubeless truck tyre valves (w/screw) Valves tubeless poids lourds pour TPMS (avec vis)	1310 WONDER	48,9	28,5	7°	9,7	
3040093T	Valvole tubeless autocarro per TPMS (vite inclusa) TPMS tubeless truck tyre valves (w/screw) Valves tubeless poids lourds pour TPMS (avec vis)	1311 WONDER	52	–	–	9,7	
3040093U	Valvole tubeless autocarro per TPMS (vite inclusa) TPMS tubeless truck tyre valves (w/screw) Valves tubeless poids lourds pour TPMS (avec vis)	1312 WONDER	48	17,5	18°	9,7	
3040093V	Valvole tubeless autocarro per TPMS (vite inclusa) TPMS tubeless truck tyre valves (w/screw) Valves tubeless poids lourds pour TPMS (avec vis)	1313 WONDER	48	17,5	28°	9,7	
3040093W	Valvole tubeless autocarro per TPMS (vite inclusa) TPMS tubeless truck tyre valves (w/screw) Valves tubeless poids lourds pour TPMS (avec vis)	1314 WONDER	48	22	25°	9,7	
3040093CB	Valvole tubeless autocarro per TPMS (vite inclusa) TPMS tubeless truck tyre valves (w/screw) Valves tubeless poids lourds pour TPMS (avec vis)	Italmatic x-ref 1392	28	28	45	9,7	



3040093C



3040093D



3040093E



3040093F



3040093G



3040093H

Codice Code	Descrizione Description	X-Ref X-Ref	Mis A mm Size A	Mis B mm Size B	Angolo Angle	Foro mm Hole	Applicazione Application
3040093EB	Valvole tubeless autocarro per TPMS (vite inclusa) TPMS tubeless truck tyre valves (w/screw) Valves tubeless poids lourds pour TPMS (avec vis)	Italmatic x-ref 1393	48	28,5	7°	9,7	
3040093C	Valvole tubeless autocarro per TPMS (vite inclusa) TPMS tubeless truck tyre valves (w/screw) Valves tubeless poids lourds pour TPMS (avec vis)	1392 WONDER	28	28	45°	9,7	
3040093D	Valvole tubeless autocarro per TPMS (vite inclusa) TPMS tubeless truck tyre valves (w/screw) Valves tubeless poids lourds pour TPMS (avec vis)	1353 WONDER	63	–	–	9,7	
3040093E	Valvole tubeless autocarro per TPMS (vite inclusa) TPMS tubeless truck tyre valves (w/screw) Valves tubeless poids lourds pour TPMS (avec vis)	1393 WONDER	48	28,5	7°	9,7	
3040093F	Valvole tubeless autocarro per TPMS (vite inclusa) TPMS tubeless truck tyre valves (w/screw) Valves tubeless poids lourds pour TPMS (avec vis)	1354 WONDER	40	–	–	9,7	
3040093G	Valvole tubeless autocarro per TPMS (vite inclusa) TPMS tubeless truck tyre valves (w/screw) Valves tubeless poids lourds pour TPMS (avec vis)	1394 WONDER	50,5	–	–	9,7	
3040093H	Valvole tubeless autocarro per TPMS (vite inclusa) TPMS tubeless truck tyre valves (w/screw) Valves tubeless poids lourds pour TPMS (avec vis)	1395 WONDER	73	–	–	9,7	

CONTRAPPESO DI INERZIA  
 BALANCING WEIGHTS  
 VALVOLE PER PNEUMATICHE  
 VALVES AND EXHAUSTS  
 COPERTURE  
 COVERS  
 PNEUMATICI E MONITORING DIUTTE  
 THE MOUNTING AND DISMOUNTING  
 OIL COMPRESSA  
 COMPRESSED AIR  
 PNEUMATICHE NEUMATICI  
 THE REPAIRING  
 SOLLEVAMENTO E ACCESSORI  
 LIFTING AND ACCESSORIES  
 OILI E MANUTENZIONE  
 TYRE CARE AND MAINTENANCE  
 ATTREZZI E ACCESSORI PER  
 OTHER EQUIPMENTS AND ACCESSORIES  
 TPMS  
 TPMS

# VALVOLE PER TRATTORE

## TRACTOR VALVES

## VALVES TRACTEUR

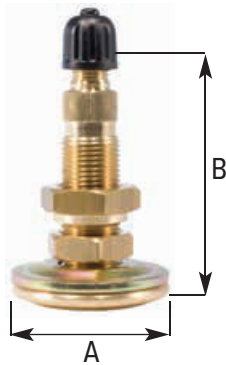

3040100  
3040100W



3040101  
3040101E  
3040101W

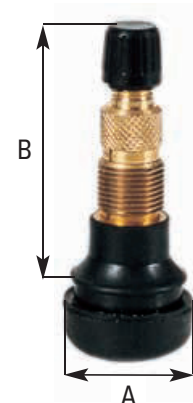

3040101A  
3040101AW



3040105C

### Valvole trattore Tractor valves Valves tracteur

Codice Code Code	Descrizione Description Description	Rif. Ref. Réf.	Mis. A Size A Dimen. A	Mis. B Size B Dimen. B	Applicazione Application Application
3040100	Valvola per camere d'aria trattore Tractor air tubes valve Valve pour chambres à air tracteur	TR218	32	51	
3040100W	Valvola per camere d'aria trattore Tractor air tubes valve Valve pour chambres à air tracteur	TRAK 18 Fer Wonder	32	51	
3040101	Valvola tubeless trattore Tractor tubeless valve Valve tubeless tracteur	TR618A	22	48	
3040101E	Valvola tubeless trattore snap-in Tractor tubeless snap-in valve Valve tubeless tracteur snap-in	TR618A Alligator	22	48	
3040101W	Valvola tubeless trattore Tractor tubeless valve Valve tubeless tracteur	TR618A Wonder	22	48	
3040101WC	Valvola Tubeless Trattore corta Tractor tubeless valve short Valve tubeless tracteur corte	TRAK 618 Fer Corto Wonder	22	35	
3040101A	Valvola tubeless trattore Snap-in Snap-in tractor tubeless valve Valve tubeless tracteur Snap-in	—	24	56	
3040101AW	Valvola tubeless trattore snap-in Tractor tubeless snap-in valve Valve tubeless tracteur snap-in	TRAK 718 Wonder	24	56	
3040101AWC	Valvola tubeless trattore snap-in corta Tractor tubeless snap-in valves short Valve tubeless tracteur snap-in corte	TRAK 718 Wonder	24	49	
3040105C	Blind valve Blind valve Blind valve	9200 Wonder	17	—	



3040105



3040106



3040106C

**Interno valvole trattore**  
**Tractor valve cores**  
**Intérieurs valves tracteur**

Codice Code Code	Descrizione Description Description	Rif. Ref. Réf.	Applicazione Application Application
3040105	Interno valvola trattore (tipo vecchio) <i>Inside part of tractor valve (old model)</i> <i>Partie intérieure valve tracteur (vieux modèle)</i>	587 CH-1	
3040106	Interno valvola trattore (tipo nuovo) <i>Inside part of tractor valve (new model)</i> <i>Partie intérieure valve tracteur (nouveau modèle)</i>	1139 CH-3	
3040106C	Interno valvola trattore (tipo nuovo) - corto <i>Inside part of tractor valve (new model) - short</i> <i>Partie intérieure valve tracteur (nouveau modèle) - court</i>	0596 Wonder	



3040203



3040204

**Attrezzi per riempimento/svuotamento acqua**  
**Tools for water filling/emptying**  
**Outils pour remplissage/vidage eau**

Codice Code Code	Descrizione Description Description	Rif. Ref. Réf.
3040203	Attrezzo svuotamento acqua <i>Water emptying tool</i> <i>Outil pour vidage eau</i>	3020
3040204	Attrezzo riempimento acqua <i>Water filling tool</i> <i>Outil pour remplissage eau</i>	3300



# VALVOLE PER MOVIMENTO TERRA









E.M. VALVES

VALVES G.C.

## Valvole tubeless Genio Civile

E.M. tubeless valves

Valves tubeless Génie Civil

Codice Code Code	Descrizione Description Description	Rif. Ref. Réf.	Mis. A Size A Dim.A	Mis. B Size B Dim.B	$\alpha$ $\alpha$ $\alpha$	Applicazione Application Application
3040115	Valvola tubeless Genio Civile E.M. tubeless valve Valve tubeless Génie Civil	TRJ650	27	80	80°	
3040115A	Valvola tubeless Genio Civile E.M. tubeless valve Valve tubeless Génie Civil	TRJ651	32	119	90°	
3040115B	Valvola tubeless Genio Civile E.M. tubeless valve Valve tubeless Génie Civil	TRJ652	27	140	86°	
3040115C	Valvola tubeless Genio Civile E.M. tubeless valve Valve tubeless Génie Civil	TRJ653	27	64	80°	
3040115E	Valvola tubeless Genio Civile E.M. tubeless valve Valve tubeless Génie Civil	TRJ655	27	80	106°	
3040116	Valvola tubeless Genio Civile E.M. tubeless valve Valve tubeless Génie Civil	TRJ657	27	102	80°	
3040116A	Valvola tubeless Genio Civile E.M. tubeless valve Valve tubeless Génie Civil	V5-07-01	27	50	92°	
3040116C	Valvola tubeless Genio Civile E.M. tubeless valve Valve tubeless Génie Civil	V5-07-04	27	75	92°	
3040116E	Valvola tubeless Genio Civile E.M. tubeless valve Valve tubeless Génie Civil	V5-07-06	27	100	92°	
3040116G	Valvola tubeless Genio Civile E.M. tubeless valve Valve tubeless Génie Civil	V5-07-02	32	50	100°	
3040116K	Valvola tubeless Genio Civile E.M. tubeless valve Valve tubeless Génie Civil	V5-07-05	25	90	90°	
3040117	Valvola tubeless Genio Civile E.M. tubeless valve Valve tubeless Génie Civil	TRJ670	41	-	-	
3040118	Valvola tubeless Genio Civile E.M. tubeless valve Valve tubeless Génie Civil	V5-06-01	41	-	-	
3040119	Valvola tubeless Genio Civile E.M. tubeless valve Valve tubeless Génie Civil	TRJ 4000/6 WONDER	29	153	90°	
3040119A	Valvola tubeless Genio Civile E.M. tubeless valve Valve tubeless Génie Civil	TRJ 4000/8 WONDER	29	203	90°	
3040119B	Valvola tubeless Genio Civile E.M. tubeless valve Valve tubeless Génie Civil	TRJ 4000/24 WONDER	29	610	90°	
3040119C	Valvola tubeless Genio Civile E.M. tubeless valve Valve tubeless Génie Civil	TRJ 4000/2.50 WONDER	29	64	90°	
3040119D	Valvola tubeless Genio Civile E.M. tubeless valve Valve tubeless Génie Civil	TRJ 4000/4.50 WONDER	29	114	90°	
3040119E	Valvola tubeless Genio Civile E.M. tubeless valve Valve tubeless Génie Civil	TRJ 4000/8.75 WONDER	29	222	90°	
3040119F	Valvola tubeless Genio Civile E.M. tubeless valve Valve tubeless Génie Civil	TRJ 4000/7.50 WONDER	29	190	90°	

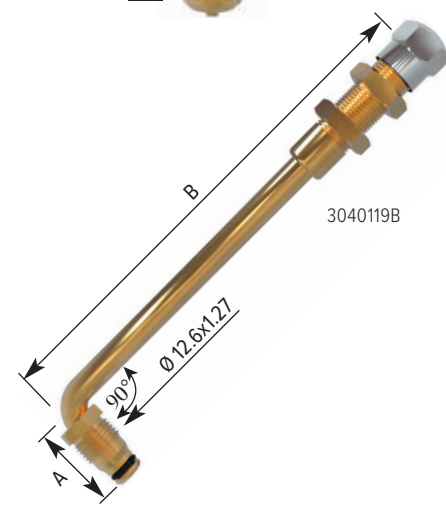
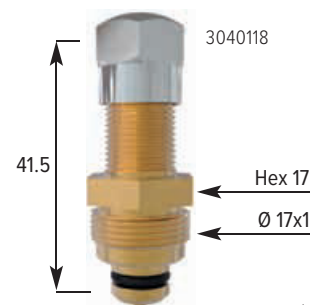
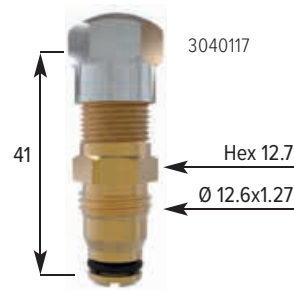
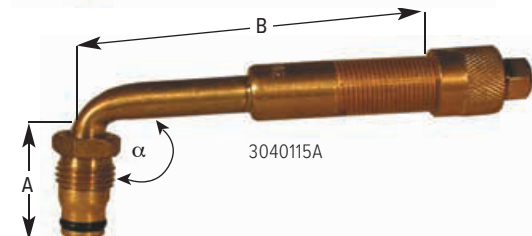
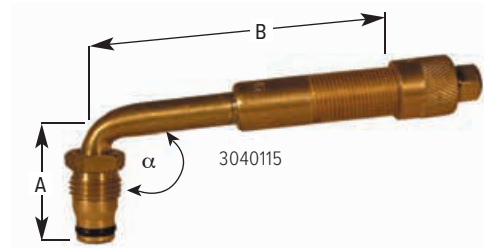



**Valvole tubeless Genio Civile**  
**E.M. tubeless valves**  
**Valves tubeless Génie Civil**

Codice Code	Descrizione Description	Rif. Ref.	Mis. A Size A Dim.A	Mis. B Size B Dim.B	$\alpha$	$\beta$	$\gamma$	Applicazione Application
3040119L	Valvola tubeless Genio Civile E.M. tubeless valve Valve tubeless Génie Civil	V5-08-1	25	90	90°	145°	145°	
3040119M	Valvola tubeless Genio Civile E.M. tubeless valve Valve tubeless Génie Civil	V5-08-2	25	92	90°	155°	155°	
3040119N	Valvola tubeless Genio Civile E.M. tubeless valve Valve tubeless Génie Civil	v5-05-1/ TRJ690	119	—	90°	152°	152°	

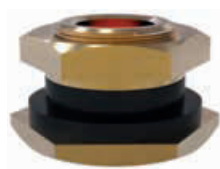

3040120



3040120C

**Base per valvola Genio Civile**  
**Base for E.M. valve**  
**Base pour valve Génie Civil**

Codice Code	Descrizione Description	Rif. Ref.	Applicazione Application
3040120	Base per valvola Genio Civile Base for E.M. valve Base pour valve Génie Civil	SP2	
3040120B	Base per valvola Genio Civile - filetto corto (16 mm) Base for E.M. valve - short thread (16 mm) Base pour valve Génie Civil - Filet court (16mm)	V5-12-2	
3040120C	Base per valvola Genio Civile - filetto lungo (21,5 mm) Base for E.M. valve - long thread (21,5 mm) Base pour valve Génie Civil - filet long (21,5 mm)	V5-12-1	
3040121	Riduzione per valvola Genio Civile Reduction for E.M. valve Réduction pour valve Génie Civil	AD/2	



**INTERNI VALVOLA E COPERCHIETTI**  
**VALVE CORES AND CAPS**  
**INTÉRIEURS ET BOUCHONS POUR VALVES**

**Accessori per valvole e prolunghe**  
**Accessories for valves and extensions - Accessoires pour valves et rallonges**

Codice Code Code	Descrizione Description Description	Rif. Ref. Réf.	Confezione Box Conditionnement
3040122	Interno valvola G.C. lungo in ottone - guarnizione Teflon nera <i>Long brass inside part - E.M. valve - black Teflon seal</i> <i>Partie intérieure laiton longue - valve G.C. - joint Teflon noir</i>	7316	1
3040122B	Interno valvola G.C. lungo nichelato con guarnizione in Teflon rossa <i>Long nickel plated inside part - E.M. valve - red Teflon seal</i> <i>Partie intérieure nickelée longue - valve G.C. - joint Teflon rouge</i>	-	1
3040123	Interno valvola G.C. corto in ottone - guarnizione Teflon rossa <i>Short brass inside part - E.M. valve - red Teflon seal</i> <i>Partie intérieure laiton courte - valve G.C. - joint Teflon rouge</i>	-	1
3040123B	Interno valvola G.C. corto nichelato con guarnizione in Teflon rossa <i>Short nickel plated inside part - E.M. valve - red Teflon seal</i> <i>Partie intérieure nickelée courte - valve G.C. - joint Teflon rouge</i>	-	1
3040126	Interno valvola corto in ottone con guarnizione in Teflon nera <i>Short valve core brass finish with black Teflon seal</i> <i>Partie intérieure courte pour valve en laiton avec joint Teflon noir</i>	1320 S	100
3040126A	Interno valvola corto in ottone con guarnizione in Teflon rossa per alte temperature <i>Short valve core brass finish with red Teflon seal for high temperatures</i> <i>Partie intérieure courte pour valve en laiton avec joint Teflon rouge pour hautes températures</i>	1320 S	100
3040126B	Interno valvola corto nichelato con guarnizione in Teflon rossa per alte temperature (raccomandato per TPMS) <i>Short valve core nickel plated with red Teflon seal for high temperatures (recommended for TPMS)</i> <i>Partie intérieure courte nickelée avec joint rouge Teflon pour hautes températures (recommandé pour TPMS)</i>	-	100
3040127	Interno valvola lunga in ottone con guarnizione in Teflon nera <i>Long valve core brass finish with black Teflon seal</i> <i>Partie intérieure longue pour valve en laiton avec joint noir Teflon</i>	1302	100
3040127A	Interno valvola lunga in ottone con guarnizione in Teflon rossa per alte temperature. <i>Long valve core brass finish with red Teflon seal for high temperatures.</i> <i>Partie intérieure longue pour valve en laiton avec joint Teflon rouge pour hautes températures.</i>	1302	100
3040127B	Interno valvola lungo nichelato con guarnizione in Teflon rossa per alte temperature. <i>Long valve core nickel plated with red Teflon seal for high temperatures.</i> <i>Partie intérieure longue nickelée avec joint rouge Teflon pour hautes températures.</i>	-	100
3040128	Cappelletto con chiave con guarnizione <i>Cap with key with seal</i> <i>Bouchon avec clef avec joint</i>	VC-2	100
3040129	Cappelletto con guarnizione nichelato <i>Cap with seal</i> <i>Bouchon avec joint</i>	VC-3	100
3040129A	Cappelletto esagonale cromato con guarnizione <i>Chromed hexagonal cap with seal</i> <i>Bouchon hexagonal chromé avec joint</i>	-	100
3040129B	Cappelletto in ottone con guarnizione <i>Metal cap with seal</i> <i>Bouchon en métal avec joint</i>	-	100
3040129C	Cappelletto in alluminio con guarnizione <i>Aluminium cap with seal</i> <i>Bouchon en aluminium avec joint</i>	-	100
3040129D	Cappelletto in alluminio nero con guarnizione <i>Aluminium black cap with seal</i> <i>Bouchon en aluminium noir avec joint</i>	-	100



**INTERNI VALVOLA E COPERCHIETTI**  
**VALVE CORES AND CAPS**  
**INTÉRIEURS ET BOUCHONS POUR VALVES**

Codice Code Code	Descrizione Description Description	Rif. Ref. Réf.	Confezione Box Conditionnement
3040129Q	Cappelletto in nylon corto Nylon short cap Bouchon en nylon court	VC-8S	100
3040130	Cappelletto in nylon lungo Long Nylon cap Bouchon en nylon longue	VC-8	100
3040130A	Cappelletto in nylon colorato rosso Red coloured nylon cap Bouchon en nylon de couleur rouge	-	100
3040130AR	Cappelletto in nylon rosso con guarnizione Red nylon cap with seal Bouchon en nylon rouge avec joint	-	100
3040130B	Cappelletto in nylon colorato verde Green coloured nylon cap Bouchon en nylon de couleur vert	-	100
3040130C	Cappelletto in nylon colorato giallo Yellow coloured nylon cap Bouchon en nylon de couleur jaune	-	100
3040130D	Cappelletto in nylon colorato blu Blue coloured nylon cap Bouchon en nylon de couleur bleu	-	100
3040130E	Cappelletto in nylon rosso con guarnizione Red nylon cap with seal Bouchon en nylon rouge avec joint	-	100
3040130G	Cappelletto in nylon nero con guarnizione Black nylon cap with seal Bouchon en nylon noir avec joint	-	100
3040130H	Cappelletto in nylon blu con guarnizione Blue nylon cap with seal Bouchon en nylon bleu avec joint	-	100
3040130J	Cappelletto in nylon verde con guarnizione Green nylon cap with seal Bouchon en nylon verte avec joint	-	100
3040130N	Cappelletto in plastica con guarnizione specifico per valvole TPMS Plastic sealing cap specific for TPMS valves Bouchon plastique avec joint pour TPMS valves	-	100
3040130V	Cappelletto Genio Civile con intaglio E.M. cap with notching Bouchon Génie Civil avec créneau	-	1
3040130W	Cappelletto Genio Civile piatto Flat E.M. cap Bouchon Génie Civil plat	-	1
3040130Y	Cappelletto Genio Civile con guarnizione E.M. cap with seal. Bouchone Génie Civil avec joint	VC-7	1
3040131	Cappelletto Genio Civile con guarnizione e chiave E.M. cap with seal and key Bouchon Génie Civil avec joint et clef	CV-6	1
3040131A	Cappelletto Double Seal - ALLIGATOR Double Seal cap Bouchon Double Seal	V2B	100
3040132	Riduzione foro valvola in gomma Hole reduction for rubber valve Réduction forure pour valve en caoutchouc	3361	100
3040133	Filiera piccola (1520S) Small die (1520S) Filière petite (1520S)	8501	1
3040135	Filiera valvole VG 5-8-12 standard Die for standard valves VG 5-8-12 Filière pour valves standard VG 5-8-12	-	1
3040136	Filiera valvole VG 5-8-12 Genio Civile Die for E.M. valves VG 5-8-12 Filière pour valves G.C. VG 5-8-12	-	1



3040129Q



3040130



3040130A



3040130B



3040130AR



3040130C



3040130G



3040130H/J



3040130E



3040130N



3040130V



3040130W



3040131



3040130Y



3040131A



3040132



3040133



3040135



3040136

CONTERPESCHI E BILANCIATORI  
BALANCING WEIGHTS  
VALVOLE PER PRODURRE  
VALVES AND EXTENSIONS  
CONFEZIONI  
PACKAGING  
MONTAGGI E SMOULTORE DI BUCHE  
THE MOUNTING AND DISMOUNTING  
OILI, COMPRESSE  
OILS, COMPRESSED AIR  
OPERAZIONE NEUMATICA  
THE REPAIRING  
SOLLEMMENTE E ACCESSORI  
LIFTING AND ACCESSORIES  
OILI E MANUTENZIONE  
OILS CARE AND MAINTENANCE  
ATTREZZATURE E ACCESSORI  
OTHER EQUIPMENTS AND ACCESSORIES  
TPMS  
TPMS



# PROLUNGHE IN GOMMA, PLASTICA E METALLO



















## RUBBER, PLASTIC AND METAL EXTENSIONS

## RALLONGES EN CAOUTCHOUC, PLASTIQUE ET MÉTAL

### Prolunghe in gomma flessibile

### Flexible rubber extensions

### Rallonges flexibles en caoutchouc

Codice Code Code	Descrizione Description Description	Note Notes Notes	Lungh. mm Length in mm Longueur en mm	Applicazioni Application Application
3040139	Prolunga in gomma flessibile Flexible rubber extension Rallonge flexible en caoutchouc		75	
3040140	Prolunga in gomma flessibile Flexible rubber extension Rallonge flexible en caoutchouc		105	
3040140W	Prolunga in gomma flessibile Flexible rubber extension Rallonge flexible en caoutchouc	Flex 105 WONDER	105	
3040140T	Prolunga in gomma flessibile Flexible rubber extension Rallonge flexible en caoutchouc		125	
3040141	Prolunga in gomma flessibile Flexible rubber extension Rallonge flexible en caoutchouc		140	
3040141W	Prolunga in gomma flessibile Flexible rubber extension Rallonge flexible en caoutchouc	Flex 140 WONDER	140	
3040141T	Prolunga in gomma flessibile Flexible rubber extension Rallonge flexible en caoutchouc		160	
3040142	Prolunga in gomma flessibile Flexible rubber extension Rallonge flexible en caoutchouc		180	
3040142W	Prolunga in gomma flessibile Flexible rubber extension Rallonge flexible en caoutchouc	Flex 180 WONDER	180	
3040143	Prolunga in gomma flessibile Flexible rubber extension Rallonge flexible en caoutchouc		210	
3040143W	Prolunga in gomma flessibile Flexible rubber extension Rallonge flexible en caoutchouc	Flex 210 WONDER	210	
3040143T	Prolunga in gomma flessibile Flexible rubber extension Rallonge flexible en caoutchouc		230	
3040143U	Prolunga in gomma flessibile Flexible rubber extension Rallonge flexible en caoutchouc		250	
3040144	Prolunga in gomma flessibile Flexible rubber extension Rallonge flexible en caoutchouc		270	
3040144W	Prolunga in gomma flessibile Flexible rubber extension Rallonge flexible en caoutchouc	Flex 270 WONDER	270	
3040145	Prolunga in gomma flessibile Flexible rubber extension Rallonge flexible en caoutchouc		335	
3040146	Prolunga in gomma flessibile Flexible rubber extension Rallonge flexible en caoutchouc		430	
3040147	Prolunga in gomma flessibile Flexible rubber extension Rallonge flexible en caoutchouc		475	



3040140W



3040141











3040148

-Altre misure disponibili a richiesta  
-Other sizes available on request  
-Autres dimensions disponibles sur demande



**Prolunghe in gomma flessibili attacco a 90°**  
**Flexible rubber extension, 90° connector**  
**Rallonges flexibles en caoutchouc, raccord 90°**

Codice Code Code	Descrizione Description Description	Note Notes Notes	Lungh. mm Length in mm Longueur en mm	Applicazioni Application Application
3040149K	Prolunga in gomma fless. con attacco angolare a 90° Flexible rubber extension with 90° angular connector Rallonge flexible en caoutchouc avec raccord angulaire 90°	Flex 125/B	125	
3040149L	Prolunga in gomma fless. con attacco angolare a 90° Flexible rubber extension with 90° angular connector Rallonge flexible en caoutchouc avec raccord angulaire 90°	Flex 140/B	140	
3040149N	Prolunga in gomma fless. con attacco angolare a 90° Flexible rubber extension with 90° angular connector Rallonge flexible en caoutchouc avec raccord angulaire 90°	Flex 210/B	210	
3040149P	Prolunga in gomma fless. con attacco angolare a 90° Flexible rubber extension with 90° angular connector Rallonge flexible en caoutchouc avec raccord angulaire 90°	Flex 250/B	250	
3040149R	Prolunga in gomma fless. con attacco angolare a 90° Flexible rubber extension with 90° angular connector Rallonge flexible en caoutchouc avec raccord angulaire 90°	Flex 270/B	270	
3040149T	Prolunga in gomma fless. con attacco angolare a 90° Flexible rubber extension with 90° angular connector Rallonge flexible en caoutchouc avec raccord angulaire 90°	Flex 330/B	330	
3040149U	Prolunga in gomma fless. con attacco angolare a 90° Flexible rubber extension with 90° angular connector Rallonge flexible en caoutchouc avec raccord angulaire 90°	Flex 370/B	370	
3040149V	Prolunga in gomma fless. con attacco angolare a 90° Flexible rubber extension with 90° angular connector Rallonge flexible en caoutchouc avec raccord angulaire 90°	Flex 430/B	430	
3040149W	Prolunga in gomma fless. con attacco angolare a 90° Flexible rubber extension with 90° angular connector Rallonge flexible en caoutchouc avec raccord angulaire 90°	Flex 475/B	475	



**PROLUNGHE IN GOMMA, PLASTICA E METALLO**  
**RUBBER, PLASTIC AND METAL EXTENSIONS**  
**RALLONGES EN CAOUTCHOUC, PLASTIQUE ET MÉTAL**



3040147K



3040148











**Prolunghe in gomma flessibile per Movimento Terra**  
**Flexible rubber extensions for E.M.**  
**Rallonges flexibles en caoutchouc pour G.C.**

Codice Code Code	Descrizione Description Description	Note Notes Notes	Lungh. mm Length in mm Longueur en mm	Applicazione Application Application
3040147K	Prolunga in gomma con treccia in acciaio G.C. Rubber extension with steel braided hose E.M. Rallonge caoutchouc tuyau acier tressé G.C.	Orflex 180 Wonder	180	
3040147L	Prolunga in gomma con treccia in acciaio G.C. Rubber extension with steel braided hose E.M. Rallonge caoutchouc tuyau acier tressé G.C.	Orflex 210 Wonder	210	
3040148	Prolunga in gomma flessibile Movim. Terra Flexible rubber extension E.M. Rallonge flexible en caoutchouc G.C.	-	300	
3040148B	Prolunga in gomma con treccia in acciaio G.C. Rubber extension with steel braided hose E.M. Rallonge caoutchouc tuyau acier tressé G.C.	Orflex 310 Wonder	310	
3040148C	Prolunga in gomma con treccia in acciaio G.C. Rubber extension with steel braided hose E.M. Rallonge caoutchouc tuyau acier tressé G.C.	Orflex 400 Wonder	400	
3040148D	Prolunga in gomma con treccia in acciaio G.C. Rubber extension with steel braided hose E.M. Rallonge caoutchouc tuyau acier tressé G.C.	Orflex 475 Wonder	475	
3040148F	Prolunga in gomma con treccia in acciaio G.C. Rubber extension with steel braided hose E.M. Rallonge caoutchouc tuyau acier tressé G.C.	Orflex 600 Wonder	600	
3040149	Prolunga in gomma flessibile Movim. Terra Flexible rubber extension E.M. Rallonge flexible en caoutchouc G.C.	-	615	
3040149C	Prolunga in gomma con treccia in acciaio G.C. Rubber extension with steel braided hose E.M. Rallonge caoutchouc tuyau acier tressé G.C.	Orflex 730 Wonder	730	
3040149D	Prolunga in gomma con treccia in acciaio G.C. Rubber extension with steel braided hose E.M. Rallonge caoutchouc tuyau acier tressé G.C.	Orflex 800 Wonder	800	



3040160













**Prolunghe in ottone**  
**Brass extensions**  
**Rallonges en laiton**

Codice Code Code	Descrizione Description Description	Lungh. mm Length in mm Longueur en mm	Applicazione Application Application
3040158	Prolunga in ottone Brass extension - Rallonge en laiton	40	 
3040159	Prolunga in ottone Brass extension - Rallonge en laiton	60	 
3040160	Prolunga in ottone Brass extension - Rallonge en laiton	84	 
3040161	Prolunga in ottone Brass extension - Rallonge en laiton	100	 
3040162	Prolunga in ottone Brass extension - Rallonge en laiton	125	 



3040156A

**Prolunghe rivestite in acciaio**  
**Steel coated extensions**  
**Rallonges habillées en acier**

Codice Code Code	Descrizione Description Description	Lungh. mm Length in mm Longueur en mm	Applicazione Application Application
3040156A	Prolunga rivestita in acciaio Steel coated extension - Rallonge habillée en acier	100	 
3040156C	Prolunga rivestita in acciaio Steel coated extension - Rallonge habillée en acier	140	 
3040156E	Prolunga rivestita in acciaio Steel coated extension - Rallonge habillée en acier	160	 
3040156G	Prolunga rivestita in acciaio Steel coated extension - Rallonge habillée en acier	180	 
3040156N	Prolunga rivestita in acciaio Steel coated extension - Rallonge habillée en acier	210	 
3040156P	Prolunga rivestita in acciaio Steel coated extension - Rallonge habillée en acier	270	 

CONTRASPORTI DI RILASCIO  
 BALANCING WEIGHTS  
 VIGOLE PROLUNGHE  
 VALVES AND EXTENSIONS  
 COPRILECCHI  
 IMPLANTS  
 MONTAGGE E MANUTENZIONE  
 TIRE MOUNTING AND DISMOUNTING  
 OBI. COMPRESSA  
 COMPRESSED AIR  
 PNEUMATICI  
 TIRE REPAIRING  
 SOLLEVAMENTO E ACCESSORI  
 LIFTING AND ACCESSORIES  
 CURA E MANUTENZIONE  
 TIRE CARE AND MAINTENANCE  
 ATTREZZI E ACCESSORI  
 OTHER EQUIPMENTS AND ACCESSORIES  
 TPMS  
 TPMS

## PROLUNGHE IN GOMMA, PLASTICA E METALLO

### RUBBER, PLASTIC AND METAL EXTENSIONS

### RALLONGES EN CAOUTCHOUC, PLASTIQUE ET MÉTAL















3040151

#### Prolunghe in plastica

#### Plastic extensions

#### Rallonges en plastique

Codice Code Code	Descrizione Description Description	Lungh. mm Length in mm Longueur en mm	Applicazione Application Application
3040150	Prolunga in plastica Plastic extension - Rallonge en plastique	71	 
3040150B	Prolunga in plastica Plastic extension - Rallonge en plastique	95	 
3040151	Prolunga in plastica Plastic extension - Rallonge en plastique	115	 
3040151B	Prolunga in plastica Plastic extension - Rallonge en plastique	125	 
3040152	Prolunga in plastica Plastic extension - Rallonge en plastique	150	 
3040153	Prolunga in plastica Plastic extension - Rallonge en plastique	170	 

















3040153J



#### Prolunghe in plastica con corpo sottile

#### Plastic extensions with slim body

#### Rallonges en plastique avec corps mince

Codice Code Code	Descrizione Description Description	Lungh. mm Length in mm Longueur en mm	Applicazione Application Application
3040153D	Prolunga in plastica Plastic extension - Rallonge en plastique	71	 
3040153E	Prolunga in plastica Plastic extension - Rallonge en plastique	95	 
3040153F	Prolunga in plastica Plastic extension - Rallonge en plastique	115	 
3040153G	Prolunga in plastica Plastic extension - Rallonge en plastique	125	 
3040153H	Prolunga in plastica Plastic extension - Rallonge en plastique	150	 
3040153J	Prolunga in plastica Plastic extension - Rallonge en plastique	170	 
3040153K	Prolunga in plastica Plastic extension - Rallonge en plastique	180	 



## PROLUNGHE IN GOMMA, PLASTICA E METALLO

RUBBER, PLASTIC AND METAL EXTENSIONS

RALLONGES EN CAOUTCHOUC, PLASTIQUE ET MÉTAL



3040175



3040175C



3040175E



3040176



3040176C



3040176E

















3040177C









### Prolunghe curve in ottone

Brass extensions

Rallonges en laiton

Codice Code Code	Descrizione Description Description	Rif. Ref. Réf.	$\alpha$ $\alpha$ $\alpha$	Lung. mm Length in mm Longueur en mm	Applicazione Application Application
3040175	Prolunga in ottone Brass extension Rallonge en laiton	-	90°	34	 
3040175C	Prolunga in ottone alta prestazione High performance brass extension Rallonge en laiton haute performance	WONDER 0352	90°	34	 
3040175E	Prolunga in ottone con chiave esagonale Brass extension with xhagonal wrench Rallonge en laiton avec clef hexagonale	-	90°	45	 
3040176	Prolunga in ottone Brass extension Rallonge en laiton	-	45°	29	 
3040176C	Prolunga in ottone alta prestazione High performance brass extension Rallonge en laiton haute performance	WONDER 0353	45°	45	 
3040176E	Prolunga in ottone con chiave esagonale Brass extension with exhagonal wrench Rallonge en laiton avec clef hexagonale	-	45°	45	 
3040177C	Prolunga in ottone alta prestazione High performance brass extension Rallonge en laiton haute performance	WONDER 0351	135°	34	 

**Piastrine di fissaggio**  
**Fixing plates**  
**Patte de fixation**

Codice Code Code	Descrizione Description Description	Rif. Ref. Ref.	Applicazione Application Application
3040168	Piastrina di fissaggio singola Single fixing plate Patte de fixation single	1144	 
3040169	Piastrina di fissaggio doppia Double fixing plate Patte de fixation double	1431	 
3040170	Piastrina di fissaggio doppia Double fixing plate Patte de fixation double	1144/2	 
3040171	Piastrina di fissaggio OTR OTR Fixing plate Patte de fixation OTR		 



3040201



3040202



3040202B



3040202D



3040202T



3040202U



3040202Z

**Misuratori battistrada**  
**Treads measurer**  
**Mesureurs de la chape**

Codice Code Code	Descrizione Description Description	Rif. Ref. Ref.
3040201	Misuratore battistrada 0÷25 mm Tread measurer - Mesureur de la chape	9796
3040202	Misuratore battistrada 0÷40 mm Tread measurer - Mesureur de la chape	-
3040202B	Misuratore battistrada digitale Digital tread measurer Mesureur de la chape digital	-
3040202D	Misuratore battistrada con quadrante analogico 0-40 mm Tread measurer with analogic dial 0-40 mm Mesureur de la chape avec cadran analogique 0-40 mm	-
3040202T	Misuratore battistrada per autocarro 0-90 Truck tread measurer 0-90 Mesureur de la chape camion 0-90	-
3040202U	Misuratore battistrada per OTR 0-145 mm OTR tyre tread measurer 0-145 mm Mesureur de la chape OTR 0-145 mm	-
3040202Z	Calibro per misura interasse fori dadi ruota Gauge to measure wheel measures hole spaces (P.C.D. gauge) Jauge pour mesurer l'empattement (P.C.D. gauge)	-

CONTROPESSI PER IL MONTAGGIO  
BALANCING WEIGHTS  
 VALVOLE PER PNEUMATICHE  
VALVES AND EXTENSIONS  
 GONFIAGGIO  
INFLATING  
 MONTAGGIO E MANTENIMENTO RUOTE  
TIRE MOUNTING AND MAINTENANCE  
 PNEUMATICO COMPRESSO  
AIR COMPRESSOR  
 PNEUMATICO  
TIRE REPAIRING  
 SOLLEVAMENTO E ACCESSORI  
LIFTING AND ACCESSORIES  
 CURA E MANUTENZIONE  
TIRE CARE AND MAINTENANCE  
 ATTREZZI E ACCESSORI VARI  
OTHER EQUIPMENTS AND ACCESSORIES  
 TPMS  
TPMS





3040184A



3040186S



3040186C



3040185

**Accessori per valvole e prolunghe**  
**Accessories for valves and extensions**  
**Accessoires pour valves et rallonges**

Codice Code Code	Descrizione Description Description	Rif. Ref. Réf.
3040183H	Svita interni singolo Single unscrew for inside parts Dispositif individuel pour dévisser les parties intérieures	-
3040184	Svita interni singolo Single unscrew for inside parts Dispositif individuel pour dévisser les parties intérieures	-
3040184A	Svita interni singolo lungo Single long unscrew for inside parts Dispositif long individuel pour dévisser les parties intérieures	-
3040184B	Svita interni singolo dinamometrico (vettura) 0,34 nm Single dynamometrical unscrew for inside parts (car) Disp. dynamometrique individuel pour dévisser les parties intérieures (voiture)	-
3040184C	Svita interni singolo dinamometrico (autocarro) Single dynamometrical unscrew for inside parts (truck) Disp. dynamometrique individuel pour dévisser les parties intérieures (camion)	-
3040185	Svita interni in plastica - vettura/G.C. Plastic unscrew for inside parts - car/E.M. Dispositif en plastique pour dévisser les parties intérieures - voiture/G.C.	1617
3040186A	Svita interni in alluminio calamitato Aluminium unscrew for inside parts with magnet Dispositif en aluminium pour dévisser les parties intérieures avec aimant	-
3040186C	Svita interni in alluminio calamitato per autocarro 151 mm Truck aluminium unscrew for inside parts with magnet 151 mm Dispositif en aluminium pour dévisser les parties intérieures avec aimant pour camion 151 mm	-
3040186S	Svita interni per sgonfiaggio silenzioso Unscrew for inside parts for silenced deflation Dispositif pour dévisser les parties intérieures pour dégonflage silencieux	0240 Wonder



3040186A



3040183H



3040184

**ATTREZZI PER MONTAGGIO, GONFIAGGIO E ACCESSORI**  
**TOOLS FOR MOUNTING, INFLATING AND ACCESSORIES**  
**OUTILS POUR MONTAGE, GONFLAGE ET ACCESSOIRES**



3040205



3040205B



3040206



3040206B



3040206D



3040206C

**Attrezzi montaggio e gonfiaggio**  
**Mounting and inflating tools**  
**Outils de montage et gonflage**

Codice Code Code	Descrizione Description Description	Rif. Ref. Réf
3040205	Attrezzo montaggio valvole in metallo <i>Tool for metal valves mounting - Outil en métal pour monter les valves</i>	9092
3040205B	Attrezzo montaggio valvole in metallo con protezione in gomma <i>Tool for metal valves mounting with rubber protection Outil pour monter les valves en métal avec protection en caoutchouc</i>	-
3040206	Attrezzo montaggio valvole in plastica <i>Plastic tool for valves mounting / Outil en plastique pour monter les valves</i>	-
3040206T	Attrezzo di montaggio valvole in gomma con sensore tpms <i>Tool to mount rubber valves with tpms sensor Outil pour montage valves en caoutchouc avec senseur tpms</i>	-
3040206A	Attrezzo Alligator montaggio valvole in plastica <i>Alligator plastic tool for valves mounting Outil Alligator en plastique pour monter les valves</i>	23.1900
3040206B	Attrezzo Alligator montaggio valvole in plastica. Con aggancio rapido valvola <i>Alligator plastic tool for valves mounting. With valve coupling Outil Alligator en plastique pour monter les valves. Avec couplage valve</i>	23.1930
3040206C	Attrezzo Alligator montaggio valvole in plastica. Con svita interni incorporato <i>Alligator plastic tool for valves mounting. With incorporated screwdriver Outil Alligator en plastique pour monter les valves. Avec dispositif pour dévisser les parties intérieures</i>	23.1940
3040206D	Attrezzo in poliammide montaggio valvole con svita interni incorporato <i>Polyamide tool to mount valves with incorporated unscrew for inside parts / Outil en polyamide pour montage valves avec dispositif pour dévisser les parties intérieures incorporé</i>	-
3040207A	Attrezzo di pescaggio valvole nel montaggio pneumatici <i>Tool to hook valves in tyre mounting Outil accroche-valves pour le montage des pneus</i>	-



3040206T

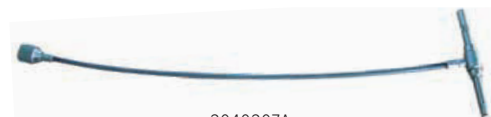

3040207A

